

Raymarine®



LIGHTHOUSE SPORT

VERSION 3.8XX

Basic operation instructions

English (en-US)
Date: 12-2018
Document number: 81384-1
© 2018 Raymarine UK Limited

Important information about this document

This document provides an introduction to using your Raymarine multifunction display, covering only basic operations.

To obtain the complete “*LightHouse Sport Advanced operations*” document, visit the Raymarine website. The document is available in 2 different formats:

1. Free download (PDF format)
2. Purchase a printed manual (paperback book format)

www.raymarine.com/manuals



Download complete manual (free)



Purchase complete printed manual

Tip: If you own a smartphone or tablet with a camera you can use the QR code shown above to visit the “LightHouse Sport Manuals and documents” area of the website directly. To use this code, download a free “QR barcode scanner” app from the Apple or Android appstore and then point the camera at the QR code on this page.

Trademark and patents notice

Raymarine, Tacktick, Clear Pulse, Truzoom, SeaTalk, SeaTalk^{hs}, SeaTalk^{ng}, and Micronet, are registered or claimed trademarks of Raymarine Belgium.

FLIR, LightHouse, DownVision, SideVision, RealVision, Dragonfly, Quantum, Axiom, Instalert, Infrared Everywhere, The World's Sixth Sense and ClearCruise are registered or claimed trademarks of FLIR Systems, Inc.

All other trademarks, trade names, or company names referenced herein are used for identification only and are the property of their respective owners.

This product is protected by patents, design patents, patents pending, or design patents pending.

Warranty registration

To register your Raymarine product ownership, please visit www.raymarine.com and register online.

It is important that you register your product to receive full warranty benefits. Your unit package includes a bar code label indicating the serial number of the unit. You will need this serial number when registering your product online. You should retain the label for future reference.

Technical accuracy

To the best of our knowledge, the information in this document was correct at the time it was produced. However, Raymarine cannot accept liability for any inaccuracies or omissions it may contain. In addition, our policy of continuous product improvement may change specifications without notice. As a result, Raymarine cannot accept liability for any differences between the product and this document. Please check the Raymarine website (www.raymarine.com) to ensure you have the most up-to-date version(s) of the documentation for your product.

Software updates



Check the Raymarine website for the latest software releases for your product.
www.raymarine.com/software

Copyright ©2018 Raymarine UK Ltd. All rights reserved.

Contents

Chapter 1 Important information	7
Disclaimers	7
Chapter 2 Set up	8
2.1 Getting started	8
Display controls	8
Startup wizard	9
First power up Limitation on Use acknowledgement	10
Configuring Transducer settings	10
Identifying engines	11
Performing a settings or factory reset	11
Importing user data	12
2.2 Shortcuts	12
2.3 Switching active app	12
2.4 Memory card compatibility	13
Removing MicroSD card from its adaptor	14
Inserting a MicroSD card	14
2.5 Software updates	15
Updating display software using a memory card	15
Updating software using an internet connection	16
2.6 Source of position data	17
Chapter 3 Homescreen	18
3.1 Homescreen overview	18
Available apps	19
Assigning app pages to Quicklaunch buttons	19
3.2 Changing an app page	20
3.3 Settings menu	21
3.4 Alarms	22
3.5 Position settings	23
Chapter 4 Chart app	24
4.1 Chart app overview	24
Chart app controls	25
Selecting a chart card	27
Chapter 5 Fishfinder app	28
5.1 Fishfinder app overview	28

Fishfinder channels	28
Fishfinder app controls	28
Switching channel frequency	31
Chapter 6 Dashboard app	32
6.1 Dashboard app overview	32
Switching data page	32
Hiding and showing data pages	32

Chapter 1: Important information



Warning: Ensure safe navigation

This product is intended only as an aid to navigation and must never be used in preference to sound navigational judgment. Only official government charts and notices to mariners contain all the current information needed for safe navigation, and the captain is responsible for their prudent use. It is the user's responsibility to use official government charts, notices to mariners, caution and proper navigational skill when operating this or any other Raymarine product.

Disclaimers

Raymarine does not warrant that this product is error-free or that it is compatible with products manufactured by any person or entity other than Raymarine.

This product uses digital chart data, and electronic information from Global Navigation Satellite Systems (GNSS) which may contain errors. Raymarine does not warrant the accuracy of such information and you are advised that errors in such information may cause the product to malfunction. Raymarine is not responsible for damages or injuries caused by your use or inability to use the product, by the interaction of the product with products manufactured by others, or by errors in chart data or information utilized by the product and supplied by third parties.

This product supports electronic charts provided by third party suppliers which may be embedded or stored on memory card. Use of such charts is subject to the supplier's End-User Licence Agreement.

Chapter 2: Set up

2.1 Getting started

Display controls

The buttons available on Element™ displays and their function are detailed below.

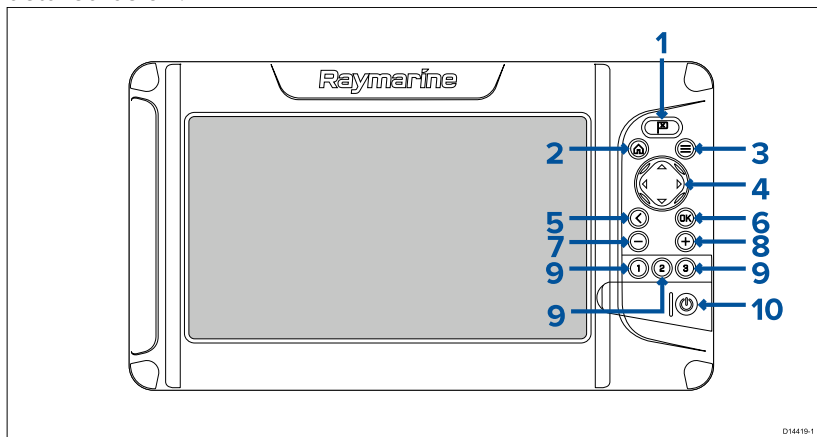

1. **Waypoint**

- Press to place a waypoint at your vessel's position (unless cursor mode is active in the Chart or Fishfinder app).
- Press to place a waypoint at the cursor's position in the Chart and Fishfinder apps (when in cursor mode).

2. **Home**

- Press to display the Homescreen.

3. **Menu**

- Press to open Homescreen menus and app menus.
- Press to close Homescreen menus and app menus.

4. **Directional pad** (8-axis directional controls)

- Use to navigate Homescreen and menus.
- Press any direction to activate cursor mode in the Chart and Fishfinder apps.
- Use to position the cursor in the Chart and Fishfinder apps.

5. **Back**

- Return to previous menu or dialog.

6. **OK** — Confirms menu selections, opens context menus

- Press to confirm a currently highlighted option.
 - Press to open context sensitive menus in the Chart and Fishfinder apps.
7. **Minus** (Zoom / Range out)
 - Press to increase the area displayed onscreen in the Chart app.
 - Press to decrease the zoom level in the Fishfinder app, when in Zoom mode.
 - Press to revert to scrolling mode from lowest zoom level in the Fishfinder app.
 8. **Plus** (Zoom / Range in)
 - Press to decrease the area displayed onscreen in the Chart app.
 - Press once to initiate Zoom mode in the Fishfinder app, subsequent presses will increase the zoom level.
 9. **Quicklaunch 1 / Quicklaunch 2 / Quicklaunch 3**
 - Press to open the assigned app page.
 - Press and hold to assign the quick launch button to the app page currently highlighted on the Homescreen.
 10. **Power**
 - Power on — Press and hold until the display beeps (approximately 2 seconds).
 - Power off — Press and hold until the display beeps (approximately 6 seconds).
 - Press once to open the shortcuts dialog.

Startup wizard

The first time the display is powered up, or after a **Factory reset** the Startup wizard is displayed.

The Startup wizard helps you to configure the following display settings:

- User interface language
- Boating activity
- Boat details (including: Safety clearances, Number of engines, Number of tanks, Number of batteries and Transducer selection.)

Follow the onscreen instructions to configure the relevant settings.

Important:

Ensure you select the correct type of transducer, an incorrect selection will require a factory reset to correct.

First power up Limitation on Use acknowledgement

After you have completed the Startup wizard the Limitation on Use (LoU) disclaimer is displayed.

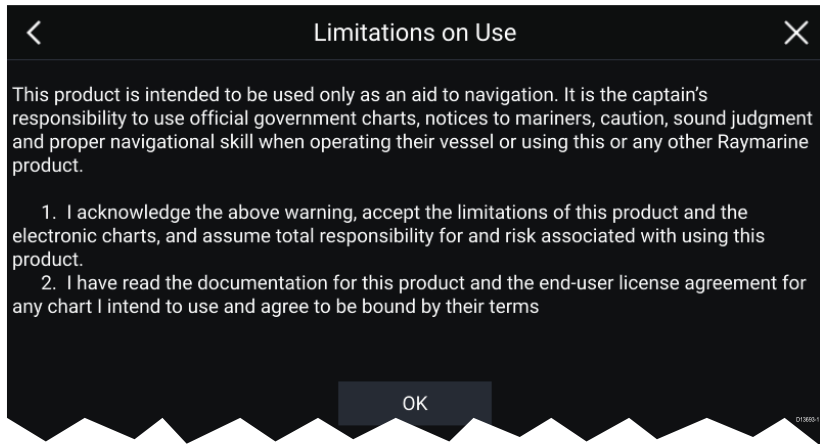

You must read and agree to the terms in order to use your display. Selecting **OK** means you have accepted the terms of use.

Configuring Transducer settings

For systems set up with a transducer connected, you should configure your transducer's settings.

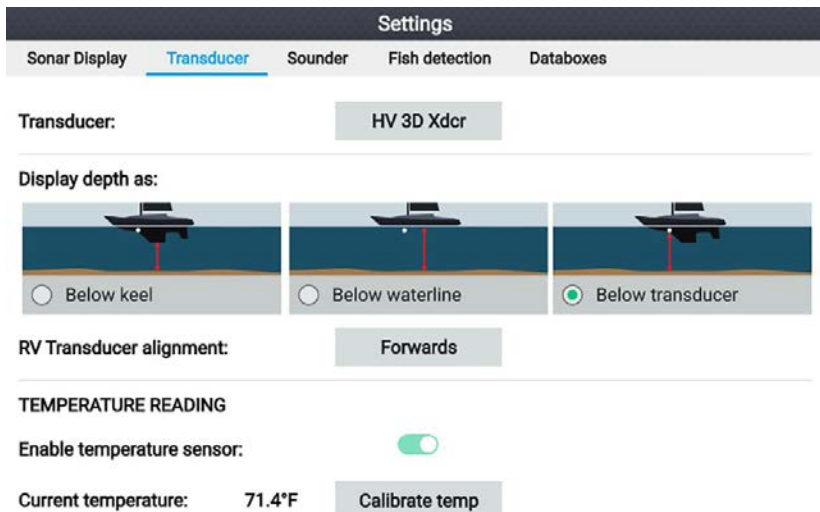

1. Select **Transducer** from the Fishfinder app's **Settings** menu: **Menu > Settings > Transducer**

2. If your installation required you to install an all-in-one transducer backwards (i.e.: the transducer's bow arrow is pointing towards the stern instead of towards the bow), then select **Backwards** from the **Transducer alignment** option. This ensures that the port and starboard channels appear correctly orientated onscreen, otherwise keep the default setting: **Forwards**.
3. Select where you want your depth measurements taken from:
 - i. Below transducer (default) — No offset required
 - ii. Below keel — Enter the distance between the transducer face and the bottom of the Keel.
 - iii. Below waterline — Enter the distance between the bottom of your Keel and the waterline.
4. You can configure temperature settings as follows:
 - i. Enable or disable temperature readings as required.
 - ii. If enabled, check the temperature reading against the actual water temperature.
 - iii. If the current reading requires adjustment, select **Calibrate temp** and enter the difference between your 2 readings.

Identifying engines

Engine data can be shown on your display, if your engines are transmitting the relevant supported data on the same network as your display. If your system has mislabelled your engines then you can correct this using the Engine identification wizard.

The Engine identification wizard can be accessed from the Boat details tab: **Homescreen > Settings > Boat details > Identify engines**.

1. Ensure the correct number of engines is selected in the **Num of Engines:** box.
2. Select **Identify engines**.
3. Follow the onscreen prompts to complete the engine identification wizard.

Performing a settings or factory reset

Performing a **Factory reset** will erase ALL user data and reset the display's settings to their Factory default values. Performing a **Settings reset** will restore your display's settings to factory defaults, whilst retaining user data.

1. Select **Settings reset**, from the **This display** tab: **Homescreen > Settings > This display > Settings reset** to perform a settings reset.
2. Select **Factory reset**, from the **This display** tab: **Homescreen > Settings > This display > Factory reset** to perform a factory reset.

Importing user data

You can import user data (i.e.: GPX format Waypoints, Routes and Tracks) to your display.

1. Insert the MicroSD card that contains your user data files into the memory card reader on your display.
2. Select **Import from card** from the Import/export page: (**Homescreen > Settings > Import/export > Import from card**).
3. Navigate to your User data file (.gpx).
4. Select the relevant GPX file.
Your user data has now been imported.
5. Select **OK**.

2.2 Shortcuts

The Shortcuts menu can be accessed Pressing the **Power** button.

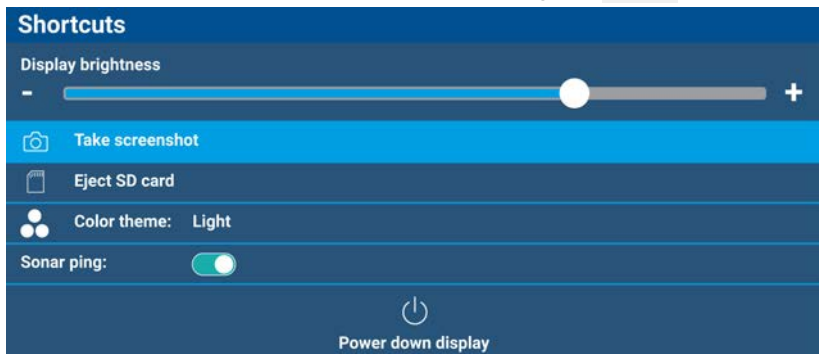

The following shortcuts are available:

- **Display brightness**
- **Take Screenshot**
- **Eject SD card**
- **Color theme**
- **Sonar ping**
- **Power down display**

2.3 Switching active app

On app pages that contain more than 1 app you can select which app is active (i.e.: which app you interact with).

With a multi app page displayed:

1. Press the **Menu** button.

2. Highlight the **Switch to** option.
3. In app pages with more than 2 apps, use the **Right** and **Left** buttons to highlight the app you want to make active.
4. Press the **OK** button.
5. Press the **Back** button to close the menu.

2.4 Memory card compatibility

MicroSD memory cards can be used to backup / archive data (e.g. Waypoints, Routes and Tracks). Once data is backed up to a memory card, old data can be deleted from the system. The archived data can be retrieved at any time. It is recommended that your data is backed up to a memory card on a regular basis.

Compatible cards

The following types of MicroSD cards are compatible with your MFD:

Type	Size	Native card format	MFD supported Format
MicroSDSC (Micro Secure Digital Standard Capacity)	Up to 4GB	FAT12, FAT16 or FAT16B	NTFS, FAT32
MicroSDHC (Micro Secure Digital High Capacity)	4GB to 32GB	FAT32	NTFS, FAT32
MicroSDXC (Micro Secure Digital eXtended Capacity)	32GB to 2TB	exFAT	NTFS, FAT32

- **Speed class rating** — For best performance it is recommended that you use Class 10 or UHS (Ultra High Speed) class memory cards, or better.
- **Use branded memory cards** — When archiving data it is recommended that you use good quality branded memory cards.

Removing MicroSD card from its adaptor

MicroSD memory and cartography chart cards are usually supplied inserted into an SD card adaptor. The card will need to be removed from the adaptor before inserting into your display.

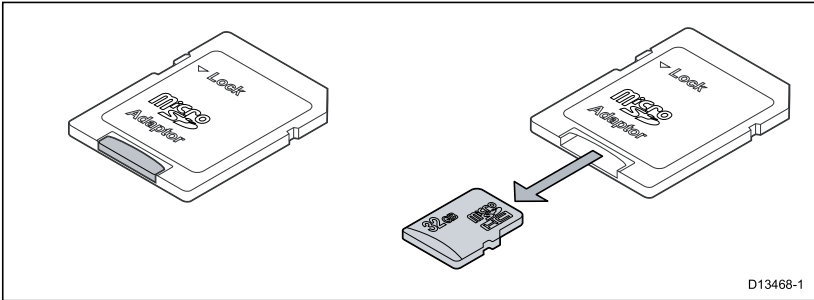

Inserting a MicroSD card

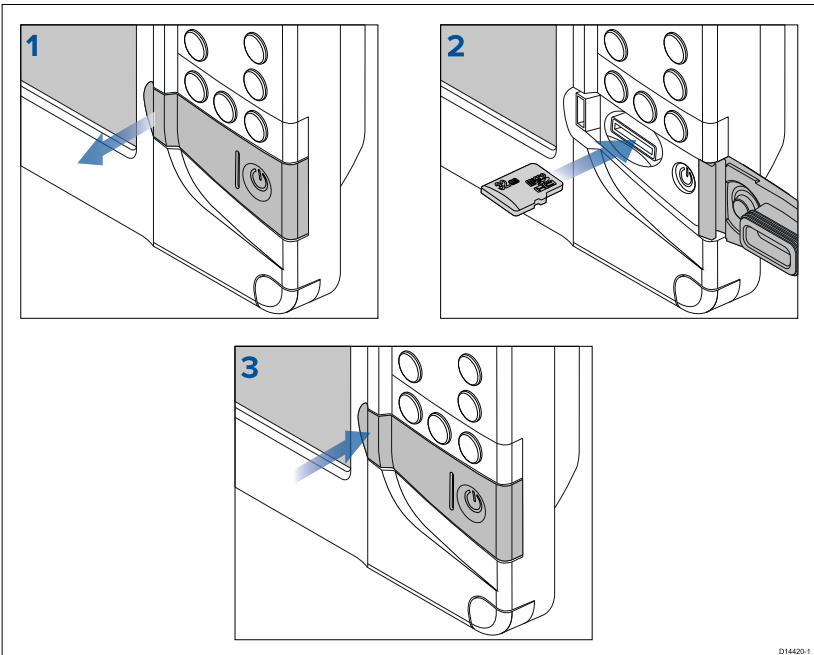

1. Open the card reader door.
2. Ensuring correct orientation (contacts facing down), insert the MicroSD card into the card reader slot.
3. Close the card reader door, ensuring that the edges of the door are flush.

Removing the MicroSD card

1. Press the **Power** button.
The **Shortcuts** menu is displayed.
2. Select **Eject SD card**.
3. Select **OK** on the confirmation dialog.
4. Open the card reader door.
5. Remove the MicroSD card from the Rear of the MFD.
6. Close the card reader door.

Caution: Ensure card reader cover or door is securely closed

To prevent water ingress and consequent damage to the product, ensure that the card reader door or cover is firmly closed.

2.5 Software updates

Raymarine® regularly issues software updates for its products which provide new and enhanced features and improved performance and usability.

It is important to ensure that you have the latest software for your products by regularly checking the Raymarine® website for new software releases.

www.raymarine.com/software

Note:

- It is recommended that you always backup your User data before performing a software update.
- The “Check online” feature is only available when the display has an active Internet connection.

Updating display software using a memory card

Follow the steps below to update the software on your display.

1. Check the software version of your product.

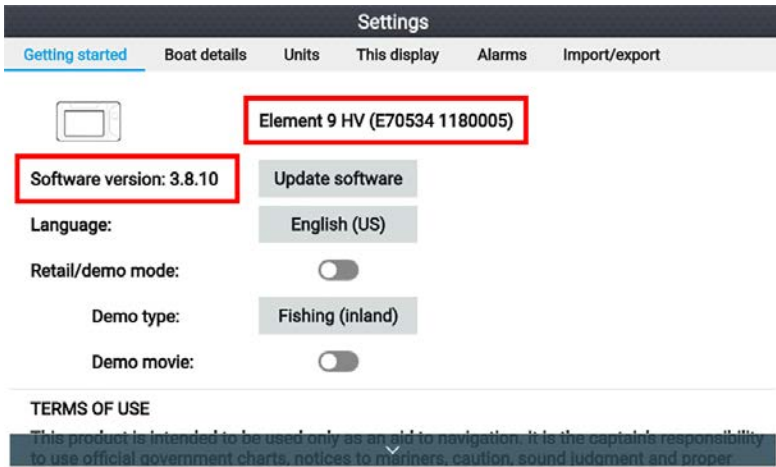

Refer to the Getting started menu: **Homescreen > Settings > Getting started** on your display to identify product variant and current software version.

2. Check the latest software for your product, available on the Raymarine website: (**www.raymarine.com > Support > Software Updates**).
3. Download the software package.
4. Copy the files to MicroSD card.
5. With your display powered on, insert the MicroSD card into the card reader slot.
The software update files will be recognized automatically.
6. Follow the onscreen instructions to update your product software.
7. Alternatively you can select **Check SD card** from the **Update software** pop-over options on the Getting started tab.

Updating software using an internet connection

Follow the steps below to update the software on your display, using an internet connection.

1. Select **Update software** from the Getting started tab: (**Homescreen > Settings > Getting started**).
2. Select **Check online** from the pop-over menu.
If you do not have an active internet connection then you will be requested to create one.
3. To set up a Wi-Fi connection select **Wi-Fi settings** and connect to the required Wi-Fi access point/hotspot.
4. Select **Start** and then follow any onscreen instructions.

2.6 Source of position data

Your display's built-in GNSS (GPS) will provide position data to a VHF radio connected to the same NMEA 2000 / SeaTalkng[®] network.

Chapter 3: Homescreen

3.1 Homescreen overview

All settings and apps can be accessed from the Homescreen.

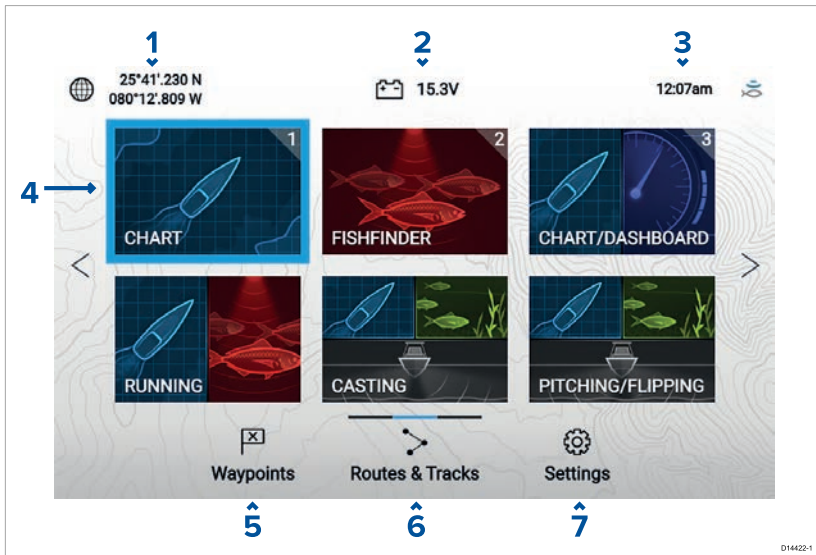



1. **Position/fix details** — Shows your vessel's current position coordinates. Select the area to view fix accuracy and to access position settings.
2. **Supply voltage** — Shows the display's supply voltage. The Voltage reading is colored Red if the current supply voltage is lower than the value specified in the **Low voltage threshold** alarm setting: **Homescreen > Settings > Alarms > Low voltage threshold**.
3. **Status area** — Displays system time, count down/up timer and sonar ping status. Select the area to set count down / up timer, time zone and to set daylight savings.
4. **App page icons** — The Homescreen is made up of 3 pages that can each contain up to 6 app page icons. Selecting an app page icon opens the relevant app page. To view a different Homescreen page, keep pressing the Directional pad's **Left** or **Right** buttons until the Homescreen page changes. You can identify which Homescreen page is being shown using the indicator bar, located above the **Routes & Tracks** icon.
5. **Waypoints** — Select to view the **Waypoints** list.
6. **Routes & Tracks** — Select to view the **Routes and Tracks** lists.
7. **Settings** — Select to view the display's **Settings** menu.

Note:

The combination of the selected **Activity** and **Transducer selection** during the Start up wizard determines the default app page icons displayed on the Homescreen.

Available apps

Apps are used in App pages. Each app page is represented on the Homescreen by an app page icon. Each app page can include up to 4 apps. The individual apps available are:

	<p>Chart — The Chart app displays electronic cartographic information from your Chart cards and when used in conjunction with a GNSS receiver, plots your vessel's position. The Chart app can be used to mark specific locations using Waypoints, build and navigate Routes or keep a record of where you have been by recording a Track.</p>
	<p>Fishfinder — The Fishfinder app uses a connected transducer to help you find fish by creating up an underwater view of bottom structure and targets in the water column that is covered by your transducer.</p>
	<p>Dashboard — The Dashboard app provides data readings from connected sensors and equipment. The Dashboard app is also used for controlling, configured, compatible, Digital Switching hardware.</p>

Assigning app pages to Quicklaunch buttons

App pages assigned to the Quicklaunch buttons are identified using the associated Quicklaunch button number in the top right corner of the app page icon.

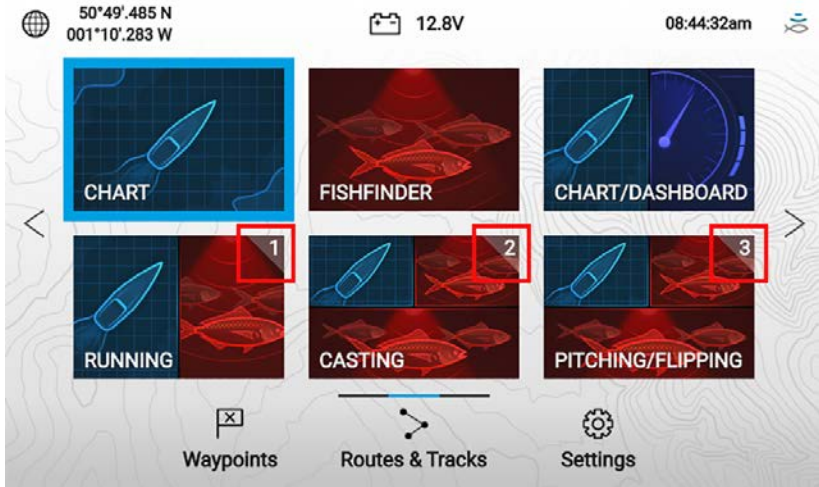

You can change which app page is assigned to the Quicklaunch buttons by following the steps below:

1. Using the **Directional pad**, highlight the app page icon that you want to assign to a Quicklaunch button.
2. Press and hold the relevant **Quicklaunch** button until the 'Quicklaunch button configured' message is displayed.
The app page icon is updated to show the associated **Quicklaunch** button number in the top right corner of the icon.
3. Repeat steps 1 and 2 for the remaining **Quicklaunch** buttons, if required.

3.2 Changing an app page

You can change an existing app page or add a new app page to the Homescreen.

1. Press and hold on an existing app page icon to display pop-over options.

*From the pop-over options you can **Customize**, **Delete**, **Rename** or assign to a **Quicklaunch** button.*

2. Select **Customize** from the pop-over options.

There are 8 layout / app combinations to choose from.

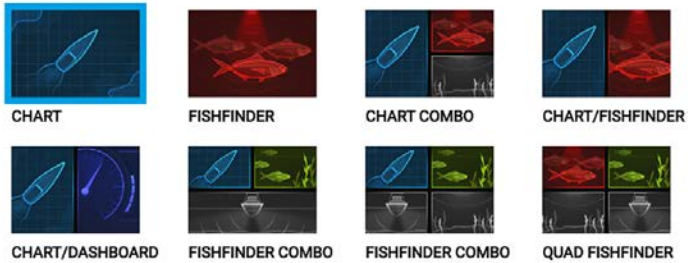

3. Select the required option.

The page is changed and the new app page icon is shown on the Homescreen.

Important:

To create a new app page, press and hold on a blank space on the Homescreen, this will take you directly to the layout selection options.

3.3 Settings menu

The display's settings can be accessed by selecting the **Settings** icon on the Homescreen.

The following settings and details are available for your display.

Tab	Settings
Getting started	<ul style="list-style-type: none"> • Hardware and software information about your display. • Update display software. • Change the user interface language. • Enable/disable Retail/demo mode (Simulator mode). • Enable/disable Demo movie. • Choose a Demo type.

Tab	Settings
	<ul style="list-style-type: none"> • View the Terms of Use disclaimer.
Boat details	<ul style="list-style-type: none"> • Configure Minimum safe depth, height and width. • Configure engines. • Configure tanks. • Configure batteries.
Units	<ul style="list-style-type: none"> • Configure preferred units of measurement. • Configure date and time settings. • Configure Bearing mode. • Configure system datum. • Configure variation.
This display	<ul style="list-style-type: none"> • Switching between Light and Dark user interface color themes. • Troubleshooting: Save or Erase error logs, Save system logs, view product information for diagnostics purposes. • Perform a Settings or Factory reset.
Alarms	<ul style="list-style-type: none"> • Configure alarm settings.
Import/export	<ul style="list-style-type: none"> • Import and export user data (Waypoints, Routes and Tracks) from MicroSD card. • Eject SD card.

3.4 Alarms

Alarms are used to alert you to a situation or hazard requiring your attention. Alarms are triggered based on their specified thresholds.

The following alarms can be configured on your display:

- Shallow depth
- Waypoint arrival
- Low voltage
- Off track
- Anchor drift
- Water temperature
- Fish detection

- Engine alarms
- Satellite lost fix

3.5 Position settings

The details and settings for your display's internal GNSS (GPS) receiver can be accessed from the Homescreen.

Satellites		
Fix	Settings	
Differential positioning:	<input checked="" type="checkbox"/>	Activating differential positioning provides more accurate positioning in regions covered by Satellite Based Augmentation Systems (SBAS).
COG/SOG filter:	Medium	Setting the COG/SOG filter according to the amount of your vessel's oscillation (e.g.: roll, pitch and yaw) provides more stable COG and SOG values.
		
Internal GPS:	<input checked="" type="checkbox"/>	Disable if you do not want to use this unit's internal GNSS receiver as a source for positioning data.
Send GPS to VHF:	<input checked="" type="checkbox"/>	Disable if your connected VHF radio has its own source of position.
Restart		

From the **Settings** tab you can:

- activate and deactivate Differential positioning (SBAS).
- set the COG/SOG filter according to the amount of vessel oscillation.
- enable and disable your display's internal GNSS (GPS) receiver (Only disable if you do not want to use positioning data on your display).
- restart the internal GNSS (GPS) receiver.

Chapter 4: Chart app

4.1 Chart app overview

The Chart app displays a representation of your vessel in relation to land masses and other charted objects, which enables you to plan and navigate to your desired destination. The Chart app requires a GNSS (GPS) position fix in order to display your vessel at the correct location on a world map.

For each instance of the Chart app you can select which electronic cartography you want to use. The selection will persist over a power cycle.

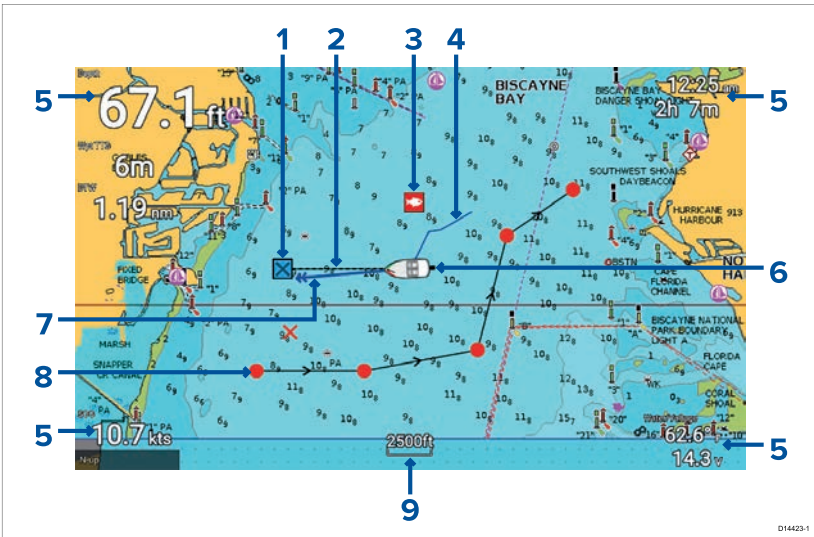

1	Destination waypoint During a Goto, this is the current destination waypoint.	2	Destination line During a Goto, a dashed line connects your vessel to the destination point.
3	Waypoint Use waypoints to mark specific locations or points of interest.	4	Track You can record the passage your vessel takes using Tracks.

5	Databoxes Databoxes display key information that is available on your system. You can configure which data is shown in each databox or the databoxes can be hidden.	6	Databoxes Databoxes display key information that is available on your system. You can configure which data is shown in each databox or the databoxes can be hidden.
7	Vessel icon This icon represents your vessel, only displayed when a GNSS (GPS) position fix is available. The icon is replaced with a Black dot if no Heading or COG data is available).	8	COG line If Course Over ground (COG) data is available, you can display a COG vector for your vessel.
9	Route You can plan your route in advance by creating a Route using Waypoints to mark each route leg.	10	Databoxes Databoxes display key information that is available on your system. You can configure which data is shown in each databox or the databoxes can be hidden.
11	Databoxes Databoxes display key information that is available on your system. You can configure which data is shown in each databox or the databoxes can be hidden.	12	Chart range Identifies the scale for the displayed Chart range.

Chart app controls

The Chart app has 2 control modes, Motion mode and Cursor mode. The behavior of some controls are dependent upon control mode.

Motion mode

Motion mode is the default mode when the Chart app is opened. In Motion mode the vessel icon remains centered onscreen and the chart area automatically pans as progress is made.

Controls behavior:

- Pressing the **OK** button opens the vessel context menu.
- Pressing any button on the **Directional pad** will switch to Cursor mode.
- Pressing the **Waypoint** button will place a waypoint at your vessel's current location.
- Pressing the **Plus** or **Minus** buttons will range in and range out respectively.

Cursor mode

In Cursor mode the chart area remains static and the vessel icon moves in the direction of travel.

Controls behavior:

- Pressing the **OK** button opens the context menu for the area or charted object directly under the cursor's position.
- Pressing any button on the **Directional pad** moves the cursor in the respective direction, when the cursor reaches the edge of the app window the chart area will pan in that direction.
- Pressing the **Waypoint** button will place a waypoint at the cursor's location.
- Pressing the **Plus** or **Minus** buttons will range in and range out respectively.
- Pressing the **Back** button will re-center the vessel icon and switch back to Motion mode.

Selecting a chart card

You can use LightHouse™ charts and compatible Navionics and C-MAP electronic charts. The electronic chart cards must be inserted into your display's MicroSD card reader.

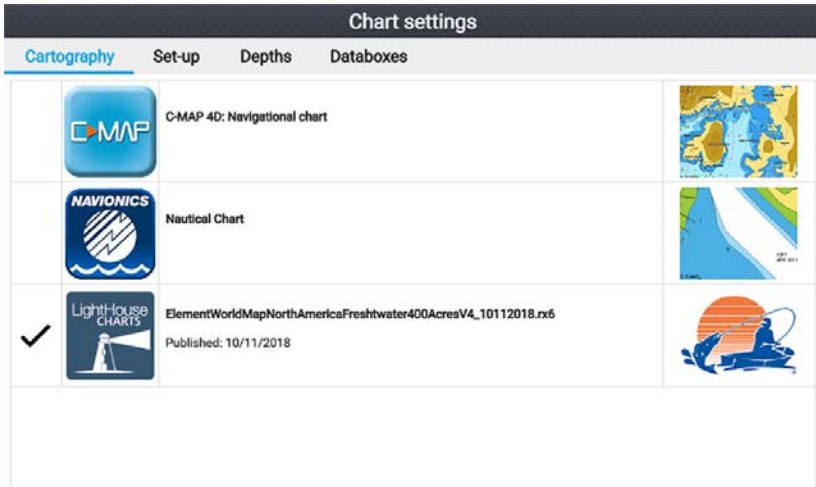

From the Chart app:

1. Press the **Menu** button.
2. Select the **Settings** icon.

*Pressing the Directional pad's **Up** button once the menu opens will move to the bottom of the menu and highlight the settings icon.*

3. Select the cartography that you want to use from the Cartography tab.

Chapter 5: Fishfinder app

5.1 Fishfinder app overview

The Fishfinder app displays a visualization of the echoes received from your connected transducer and builds an underwater scrolling view of bottom structure and targets that pass under your transducer.

For each instance of the Fishfinder app you can select which channel that you want to use. Channel selection will persist over a power cycle.

Fishfinder channels

The following Fishfinder channels are available.



RealVision™ 3D (350 kHz / 1.2 MHz)



SideVision™ (350 kHz / 1.2 MHz)

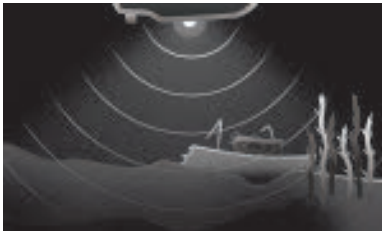

DownVision™ (350 kHz / 1.2 MHz)



Conical high CHIRP
(200 kHz)

Fishfinder app controls

The Fishfinder app has 2 control modes, Scrolling mode and Pause / Playback mode. The behavior of some controls are dependent upon control mode and also the Fishfinder channel being displayed. The

following controls apply to DownVision™, SideVision™ and Conical sonar channels. The controls below do not apply to RealVision™ channels.

Scrolling mode

Scrolling mode is the default mode when the Fishfinder app is opened. In Scrolling mode an image is displayed which scrolls from right to left across the screen.

Control behavior:

- Pressing the **Plus** button will switch to Zoom mode.
- When in Zoom mode pressing the **Plus** or **Minus** buttons will increase and decrease the zoom level.
- Pressing the **OK** button displays the onscreen gain controls on the left side of the screen.
- Pressing the **Waypoint** button will place a Waypoint at your vessels' current location.
- Pressing the **Menu** button will open the app menu.
- Pressing any button on the **Directional pad** will switch to Pause / Playback mode.

Pause / Playback mode

In Pause / Playback mode the image is temporarily paused and the cursor can be moved around the screen.

Control behavior:

- Pressing the **Plus** button will switch to Zoom mode and the scrolling image remains paused.
- When in Zoom mode pressing the **Plus** or **Minus** buttons will increase and decrease the zoom level.
- Pressing the **OK** button displays the Fishfinder context menu.
- Pressing the **Waypoint** button will place a Waypoint at the cursor's location.
- Pressing any button on the **Directional pad** will move the cursor in that direction.
- With the cursor at the far left of the screen, continuing to press the Left button will display the scrolling image history, which enables you to view structure and targets you have already passed.
- Pressing the **Menu** or **Back** button will return the Fishfinder app to scrolling mode.

RealVision™ app controls

When viewing RealVision™ channels the controls behave differently to other Fishfinder channels.

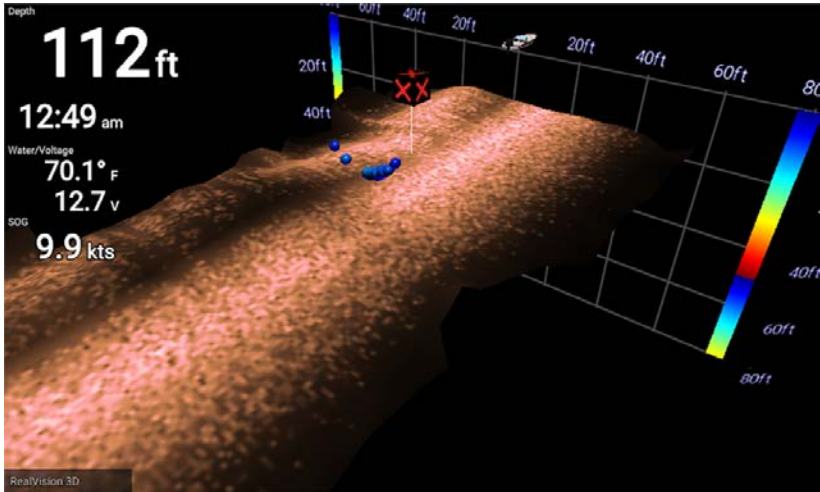

Scrolling mode

Scrolling mode is the default mode when the Fishfinder app is opened. In Scrolling mode an image is displayed which scrolls across the screen.

Control behavior:

- Pressing the **Plus** or **Minus** buttons will increase and decrease the zoom level.
- Pressing any button on the **Directional pad** will rotate the image in the respective direction.
- Pressing the **Waypoint** button will place a Waypoint at your vessels's current location.
- Pressing the **Menu** button will open the app menu.
- Pressing the **OK** button pauses scrolling and switches to Pause / Playback mode.

Pause / Playback mode

In Pause / Playback mode the image is paused and the cursor can be moved around the screen.

Control behavior:

- Pressing the **Plus** or **Minus** buttons will increase and decrease the zoom level.
- Pressing the **OK** button displays the Fishfinder context menu.

- Pressing the **Waypoint** button will place a Waypoint at the cursor's location.
- Pressing any button on the **Directional pad** will move the cursor in that direction.
- With the cursor positioned at the opposite edge of the screen to the vessel icon, continuing to move the cursor in the same direction will display the scrolling image history, which enables you to view structure and targets you have already passed.
- Pressing the **Menu** button will return the Fishfinder app to scrolling mode and open the app menu.
- Pressing the **Back** button will return the Fishfinder app to scrolling mode.

Switching channel frequency

DownVision™, SideVision™ and RealVision™ channels are available in both 350 kHz (Standard) and 1.2 MHz (Hyper) frequencies.

With a dual frequency channel displayed:

1. Press the **Menu** button.
2. Select the **Freq:** option.
3. Select either **Standard (350 kHz)** or **HyperVision (1.2 MHz)** as required.

HyperVision™ channels provide higher resolution than standard channels with reduced range.

Chapter 6: Dashboard app

6.1 Dashboard app overview

The Dashboard app enables you to view system data. System data may be generated by your display or by devices connected to your display via SeaTalkng® / NMEA 2000.

Note: For data to be available in the Dashboard app it must be transmitted to your display from compatible hardware using supported protocols and messages.

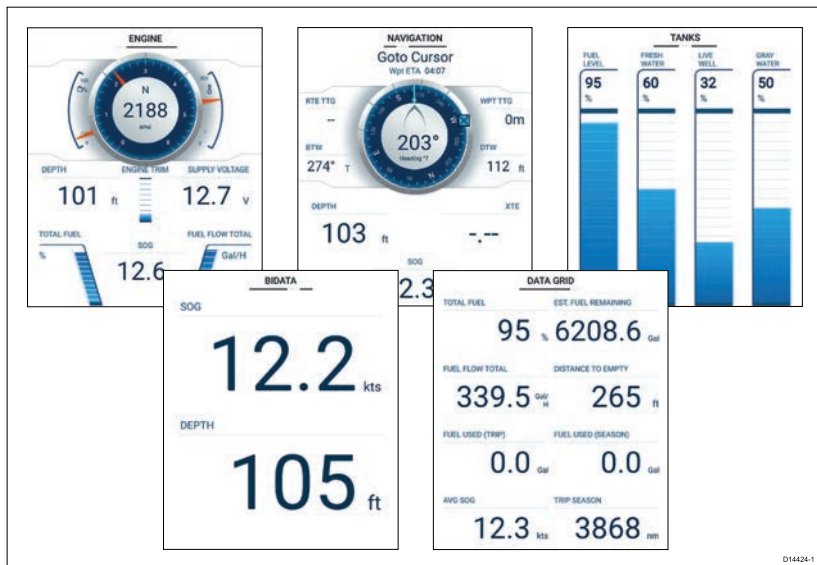

You can configure which Data pages you want visible in the Dashboard app, the Data page selection will persist over a power cycle.

The Dashboard app is pre-configured with a number of customizable data pages.

Switching data page

When the Dashboard app is the active app you can cycle through the available data pages.

1. Use the **Left** and **Right** buttons to cycle through the available data pages.

Hiding and showing data pages

With the Dashboard app displayed and active:

1. Press the **Menu** button.
2. Select the **Settings** icon.
The menu is opened on the **Pages** tab.
3. Using the **Up** button and **Down** button, highlight the page you want to hide or show.
4. Press the **OK** button.
5. Select either **Hide page** or **Show page**.
6. Press the **Menu** button to close the menu.



Raymarine

Marine House, Cartwright Drive, Fareham, Hampshire.
PO15 5RJ, United Kingdom.

Tel: +44 (0)1329 246 700

www.raymarine.com

Raymarine®

a brand by  **FLIR®**